



1. Intended use:

The RACK 19" cabinet enables integrating CCTV, AC, I&HAS, RTV, LAN, or other systems in medium and big companies. It is intended for devices manufactured in enclosures of the 19" standard. Due to the RACK cabinets, the devices are aesthetically mounted and protected against mechanical damage.

2. Specifications:

SPECIFICATIONS	
Mounting dimensions:	W=19", H=15U, D=360mm
External dimensions:	W=600, H=855, D=600 [mm, +/-2]
Net/gross weight:	43 / 47 [kg]
Materials:	<ul style="list-style-type: none"> - RACK mounting rails: cold-rolled steel SPCC 2mm – bolted - horizontal mounting rails: cold-rolled steel SPCC 1,5mm - bolted - frame: cold-rolled steel SPCC 1,2mm RAL 9004 - welded - front door: 5mm toughened glass / SPCC 1,2mm RAL 9004 - hinged - side panels: cold-rolled steel SPCC 1,2mm RAL 9004 - removable - rear door: cold-rolled steel SPCC 1,2mm RAL 9004 - hinged
Static load:	1000 kg (with leveling feet)
Use:	inside, IP20
Notes:	<ul style="list-style-type: none"> - adjustable distance between front and rear RACK rails - ventilation holes in the front door, top and bottom panel - possible mounting of a fan unit in the top panels - RAWP600 (max. 2 pcs.) - cable ducts in the top and bottom panel - 4 casters without brakes and 4 leveling feet included - possible assembly of a 100mm high plinth - RAC166M - lockable front door (2 keys included) - lockable rear door (2 keys included) - side panels - lock assembly possible - RAZB16 - fully assembled
Declarations, warranty:	RoHS, 12 months from the date of purchase

3. Structure of the RACK cabinet.

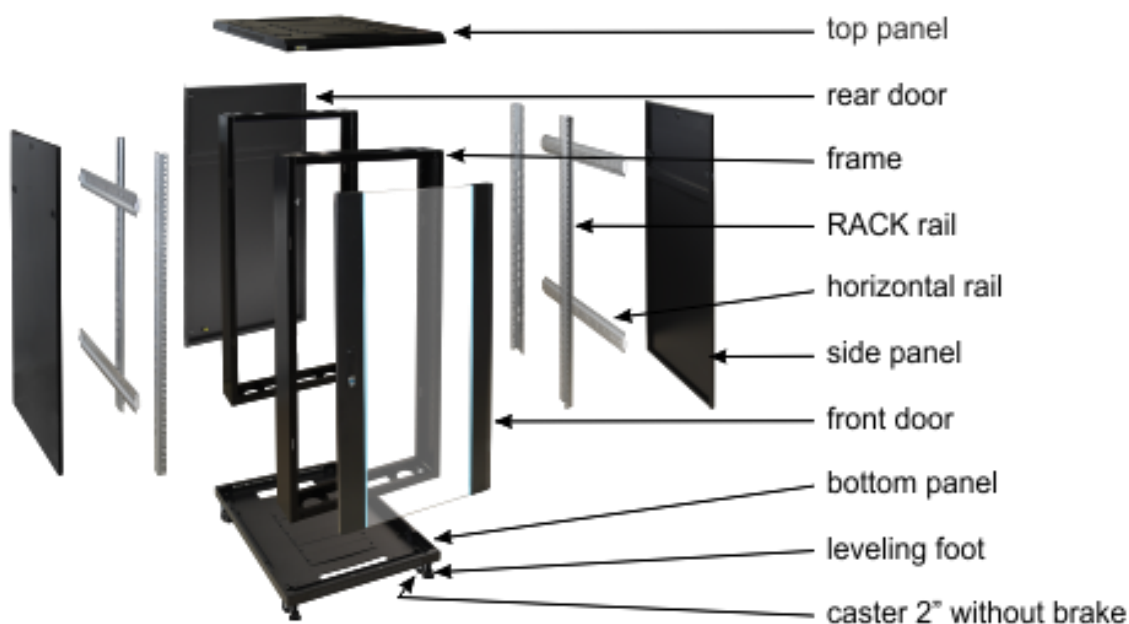

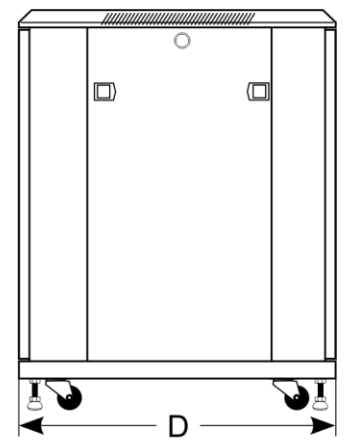
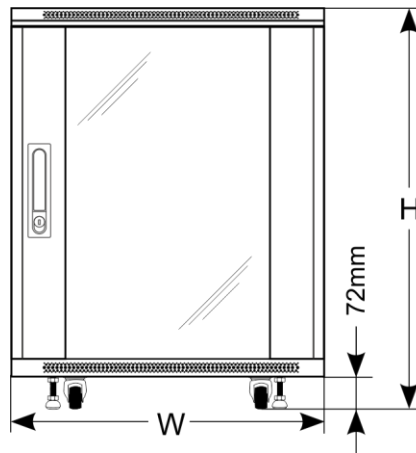
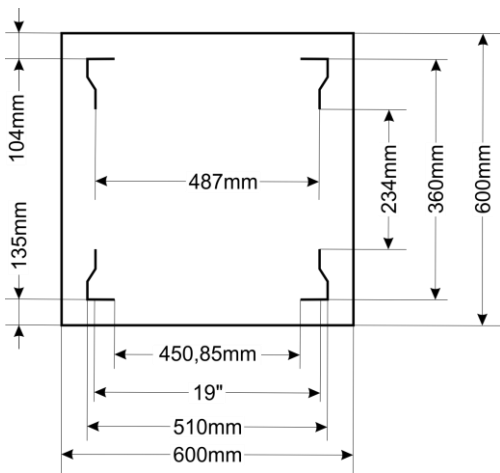

MANUFACTURER

Pulsar sp. j.

Siedlec 150,

32-744 Łapczyca

Tel. 14-610-19-40, Fax. 14-610-19-50

e-mail: biuro@pulsar.pl, sales@pulsar.pl

http:// www.pulsar.pl, www.zasilacze.pl